



Operations Manual



ECR20013 ***SIX-REEL SUBSTATION RECOVERY*** ***TRAILER***

QUICK FACTS ABOUT YOUR TRAILER

MAXIMUM PAYLOAD CAPACITY 8,800 LBS.

MGS Incorporated , 178 Muddy Creek Church Road, Denver, PA 17517
PH 1-800-952-4228



MGS Inc. was established in 1962 by owner and president Roland Gehman. The company's corporate culture is a direct reflection of Roland's desires, capabilities, and attitudes. These attitudes have developed from his experiences and relationships with his family, education, church, volunteer groups, business associates and MGS employees. We are staffed with an extraordinary group of talented people. The members of MGS consist of : salesmen, welders, sales support personnel, press and shear operators, engineers, tow motor operators, shipping and receiving personnel, purchasing agents, production controllers, administrative personnel, supervisors, painters, mechanics, cad operators, maintenance men, truck drivers, carpenters, and managers. All of which, have an impact on who we are:

INNOVATORS AND MANUFACTURERS OF TRANSPORTATION EQUIPMENT

The MGS Mission :

It is our mission to provide *the best total solution* for our customers, clients and alliance partners. These solutions are built like our products, with TEAMWORK. The combined expertise and efforts of the MGS team is what keeps us **one of a kind - not one of a group!**

About Your Trailer

MGS Model No.	ESR20013
Description	Six Reel Substation Recovery Trailer
GAWR	#7,000
GVWR	#15,400
Empty Weight	#4,260
Unladen Hitch Weight	#660
Payload Capacity	#8,800
Tire Size	235/80R16 LRG
Coupler	Eye 3" - 4 bolt Adjustable
Electrical Connection	7 way plug

TRAILER OPERATIONS MANUAL: TABLE OF CONTENTS

SECTION 1 : SAFETY INFORMATION

1.1 Safety Symbol and Signal Words

1.2. Major Hazards

- 1.2.1 Driving Too Fast
- 1.2.2 Changed Handling Due to Trailer
- 1.2.3 Incorrect Coupling of Trailer to Tow Vehicle
- 1.2.4 Incorrect Use of Safety Chains and Breakaway Brake
- 1.2.5 Mismatch Between Trailer and Hitch
- 1.2.6 Tires and Wheels
- 1.2.7 Weight and Load Distribution
- 1.2.8 Shifting Cargo
- 1.2.9 Brakes, Lights and Mirrors
- 1.2.10 Hazards From Modifying Your Trailer
- 1.2.11 Regular Maintenance and Safety inspection
- 1.2.12 Reporting Safety Defects

SECTION 2 : PREPARING TO TOW

2.1 Providing an Adequate Tow Vehicle and Hitch

- 2.1.1 Trailer Information
- 2.1.2 Trailer Braking System
- 2.1.3 Tow Vehicle

2.2 Coupling the Trailer

- 2.2.1 Trailer with Ball Hitch Coupler
- 2.2.2 Trailer with Pintle Eye Coupler
- 2.2.3 Breakaway System Electric
- 2.2.4 Breakaway System Hydraulic

2.3 Loading the Trailer

- 2.3.1 Checking Tongue Weight
- 2.3.2 Loading Cargo

2.4 Checking the Trailer Before and During Each Tow

2.5 Breaking in a New Trailer

2.6 Synchronizing the Brakes (Electric brakes only)

2.7 Uncoupling the Trailer

- Ball Hitch/Tongue Jack Uncoupling

SECTION 3 : TRAILER TOWING GUIDE

SECTION 4 : TECHNICAL REFERENCE

4.1 Trailer Lighting Electrical Connection

4.2 Specific Operation ESR20013

- 4.2.1 Specialized Equipment

4.3 Dimensions/Weight

SECTION 1 : SAFETY INFORMATION

This operator's manual is for trailers manufactured by MGS Incorporated. Read this manual before loading or towing your MGS trailer. Follow all of the safety precautions and instructions in this manual.

This manual contains safety information, instructions and warnings for protection against death and serious injuries, including:

- Death or serious injury from loss of control of the trailer, or the trailer/tow vehicle combination.

The most common causes for loss of control of your trailer are:

- Driving too fast for conditions (trailer maximum speed = 60 m.p.h.);
- Failure to properly couple the trailer to the hitch;
- Inadequate tow vehicle or towing hitch;
- Absence of braking on trailer;
- Failure to maintain proper tire pressure;
- Failure to keep lug nuts tight;
- Overloading or uneven loading of the trailer; and
- Failure to properly maintain the trailer structure.

A general trailering manual cannot provide all of the specific details necessary for the proper combination of trailer, tow vehicle and hitch that you have. Therefore, it is your responsibility to read, understand and follow the instructions of the towing vehicle and trailer hitch manufacturers, as well as the instructions in this manual.

The safety information in this manual is highlighted by the following safety alert symbol:



DANGER

DANGER - Immediate hazards which **WILL** result in severe personal injury or death if the warning is ignored.



WARNING

WARNING - Hazards or unsafe practices which **COULD** result in severe personal injury or death if the warning is ignored.



CAUTION

CAUTION - Hazards or unsafe practices which could result in minor or moderate injury if the warning is ignored.

NOTICE

Practices which could result in damage to the trailer or other property.

SECTION 1 : SAFETY INFORMATION

1.2.1 Driving Too Fast



WARNING

Driving too fast for conditions can result in loss of control and cause death or serious injury. Adjust speed down when towing a trailer.

The maximum speed that the trailer can be safely towed, under ideal road conditions, is 65 miles per hour unless specified otherwise. Do not tow your MGS trailer faster than this. The tires on the trailer will overheat and possibly blow out if you drive too fast. Also, the likelihood of suddenly losing control increases as your speed increases.

1.2.2 Changed Handling Due to Trailer

When towing the trailer, you will have:

Slower acceleration;
Increased stopping distance;
Increased turning radius - watch inside corner;
Longer distance to pass, due to slower acceleration, and increased length.

- Beware of slippery conditions. A tow-vehicle/trailer combination is more likely to be affected by slippery road surfaces, than a tow vehicle without a trailer.
- Anticipate the trailer reaction to the air pressure wave caused by passing trucks and busses, this reaction is termed “swaying.”
- Use rearview mirrors frequently to observe both the trailer behavior and traffic patterns.
- Use lower gear when going down steep or long grades. Do not ride the brakes, because they can overheat to the point of becoming completely ineffective. Use the engine and transmission as a brake.
- Keep the height of your trailer and load in mind, especially when approaching roofed areas and when around trees.

1.2.3 Incorrect Coupling of Trailer to Tow Vehicle

A secure coupling, including the correct attachment of the safety chains, is vital. A loss of coupling may result in death or serious injury.



WARNING

Coupler-to-hitch mismatch can result in uncoupling, leading to death or serious injury. Make sure the hitch and ball / pintle hook and lunette eye are rated for the trailer. Make sure the hitch [ball/ lunette eye size] matches the coupler.



WARNING

Coupler and hitch selection and condition are critical for safe towing. Uncoupling can result in death or serious injury.

- Make sure the hitch and ball/pintle hook and lunette eye are rated for the trailer.
- Make sure the hitch [ball size] matches the coupler.
- Check the hitch ball for wear, corrosion and cracks before coupling. Replace worn, corroded or cracked hitch ball before coupling the trailer. Check pintle hook/lunette eye for wear, cracks and corrosion. Replace if worn cracked or corroded.
- Make sure the hitch ball nut is tight before coupling the trailer.



WARNING

An improperly coupled trailer can result in death or serious injury.

Do not move the trailer until:

- the coupler is secured and locked;
- the safety chains are secured to the tow vehicle
- the trailer jacks are fully retracted.

Do not tow the trailer on the road until:

- the trailer brakes are checked;
- the breakaway cable/chain is connected to the tow vehicle
- the trailer lights are connected.

1.2.4 Incorrect Use of Safety Chains and Breakaway Brake

Safety chains are provided so that control of the trailer can be maintained, even if the trailer comes loose from the hitch for any reason. To be effective, safety chains must be in good condition and be properly rigged.

SECTION 1 : SAFETY INFORMATION

WARNING

Incorrect rigging of the safety chain can result in loss of control of the trailer and tow vehicle, leading to death or serious injury, if the trailer uncouples from the tow vehicle.

Chains must:

- **Fasten to frame of tow vehicle, not to hitch or ball.**
- **Cross underneath hitch and coupler with minimum slack to permit turning and to hold tongue up, if the trailer comes loose.**

Your trailer may be equipped with a breakaway brake system, in addition to having safety chains. This system will apply the brakes on your trailer if the trailer comes loose from the hitch for any reason. To be effective, the breakaway brake system must be in good condition, and be properly rigged.

WARNING

An ineffective breakaway brake system can result in a runaway trailer, if the coupler or ball hitch fails, leading to death or serious injury.

- **Test the function of the breakaway brake system before towing the trailer. Do not tow the trailer if the breakaway brake system is not working; have it serviced or repaired.**
- **Connect the breakaway cable to the tow vehicle -**
 - **NOT to the safety chain; and**
 - **NOT to the hitch, ball or support.**
- **Rig the breakaway cable/chain so that if the trailer becomes uncoupled, the safety chains will not prevent the system from being activated.**

1.2.5 Mismatch Between Trailer and Hitch

WARNING

Use of an underrated hitch, ball or tow vehicle can result in loss of control leading to death or serious injury. Make certain your hitch and tow vehicle are rated for your trailer.

1.2.6 Tires and Wheels

Tire or wheel failure can result in loss of control of the trailer and the towing vehicle. Death or serious injury may result.

Trailer tires and wheels are more likely to fail than car tires and wheels because they carry a heavier load.

Therefore, it is critical that you develop the necessary habit of always inspecting the trailer tires before towing the trailer.

If tire pressure is too low or too high, the trailer will not be stable, and a tire may blowout or otherwise fail while underway.

The tires must be inflated to the proper pressure before getting underway. Trailer tires are designed to be inflated to higher pressures than passenger vehicle tires.

Tire pressure must be checked “cold.” Allow 3 hours cool down after driving as much as 1 mile at 40 m.p.h., before checking pressure.

WARNING

Improper tire pressure causes an unstable trailer. Blow out and loss of control may occur. Death or serious injury can result. Make sure of proper tire pressure before towing trailer. Inflate tires to pressure indicated on side wall.

If the tires have too little tread, they will not provide adequate tracking on wet roadways. This can result in loss of control of the towing vehicle and trailer. Death or serious injury may result.

Inspect the trailer tires before each tow. If a tire has a bald spot, bulge, cuts, is showing any cords, or is cracked, replace the tire before towing the trailer.

Uneven tread wear can be caused by tire imbalance, axle misalignment or improper inflation. If you observe uneven tread wear, take the trailer to a service center for diagnosis.

SECTION 1 : SAFETY INFORMATION

Lug nuts or bolts can shift and settle quickly after being first assembled. You must check the lug nuts for tightness after the first 10, 25 and 50 miles of driving a new trailer (or remounted wheel), and before each tow thereafter. Trailer wheels and lug nuts are subjected to greater side loads than automobile wheels. This can cause the lug nuts to become loose.

Failure to perform this check may result in a wheel parting from the trailer, and a crash leading to death or serious injury.



WARNING

Lug nuts are prone to loosen after being first assembled. Death or serious injury can result. Check lug nuts for tightness on a new trailer, and after remounting a wheel at 10, 25 and 50 miles.

You must use a torque wrench to obtain the proper tightening of the lug nuts (or bolts). If you do not have a torque wrench, tighten the lug nuts with a lug wrench as much as you can, then have the lug nuts tightened to the proper torque at a service garage



WARNING

Inadequate lug nut torque can cause a wheel to part while towing. Death or serious injury can result. Make sure lug nuts are tight before towing trailer.

1.2.7 Weight and Load Distribution

Proper loading of your trailer is essential for your safety. Tire, wheel, axle or structural failure can be caused by overloading.



WARNING

**An overloaded trailer can result in failure or in loss of control of the trailer, leading to death or serious injury.
Never load a trailer so that the weight on any tire exceeds its rating.
Never exceed the trailer Gross Vehicle Weight Rating (GVWR).
Never exceed an axle Gross Axle Weight Rating (GAWR).
Do not exceed the rating of any of the hitch components**

Steps for Determining Correct Load Limit-

- (1) Locate the statement "The weight of cargo should never exceed XXX kg or XXX lbs." on your vehicle' placard.
- (2) This figure equals the available amount of cargo and luggage load capacity."
- (3) Determine the combined weight of luggage and cargo being loaded on the vehicle. That weight may not safely exceed the available cargo and luggage load capacity.

Proper handling of your trailer depends on having the trailer load distributed properly. A proper weight distribution is equal, right to left; and depends on proper tongue weight for stable trailer handling. Rules of thumb for proper tongue weight are:

10 - 15% of GVW

The trailer is more stable when its center of gravity is low.

- Load heavy items on the floor and over the axles.
- Load additional items to maintain even weight distribution and to achieve desired tongue weight.



WARNING

An improperly distributed load can result in loss of control of the trailer, and can lead to death or serious injury.

- Proper tongue weight is essential for stable trailer handling.
- Distribute the load front to rear to provide proper tongue weight.
- Distribute the load evenly, right and left, to avoid tire overload.
- Keeping the center of gravity low and centered is essential to minimize the risk of tip-over.

1.2.8 Shifting Cargo

You are responsible to secure your cargo in such a way that it does not shift within the trailer, while the trailer is being towed. The "ride" inside a trailer can be very bumpy and rough.



WARNING

A shifting load can result in failure, or to loss of control of the trailer, and can lead to death or serious injury.

You must tie down all loads with proper sized fasteners, ropes, straps, etc. to prevent the load from shifting while trailering.



WARNING

Always secure the door/gate latch after closing. Place a spring pin in the catch. If the door/gate opens, your cargo may be ejected onto the road.

SECTION 1 : SAFETY INFORMATION

1.2.9 Brakes, Lights and Mirrors

The brakes and lights on your trailer are controlled via a multi-pin electrical connector. If your trailer is equipped with an electric service brake trailer brake operation is critical for slowing the trailer. Lights are necessary for drivers behind you to see you at night, and be alerted to your intended moves. Make certain that the brakes and all of the lights on your trailer are functioning properly before towing your trailer on the road.

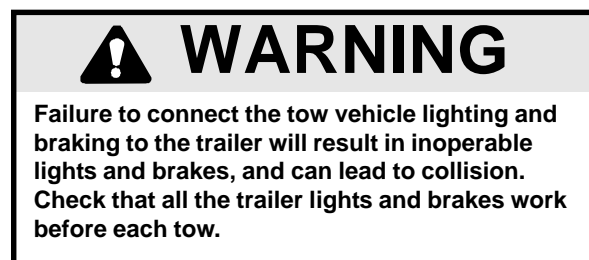

Standard mirrors usually do not provide adequate visibility for viewing traffic to the sides and rear of a trailer under tow. You are responsible to provide mirrors that permit you to safely maneuver in traffic.

1.2.10 Hazards From Modifying Your Trailer

Before making modifications to your MGS trailer, please contact MGS to be sure that such modifications will not make your trailer unsafe or unusable.

1.2.11 Regular Maintenance and Safety inspection

Your MGS trailer will require periodic maintenance and safety inspections. Please refer to the component information included in this packet for proper operation and maintenance of specific components.

It is recommended that a safety inspection be performed on your trailer at least once per year. Some states require a safety inspection. Check with your local authorities to determine if your trailer qualifies.

1.2.12 Reporting Safety Defects

Please report all safety defects to:
MGS Incorporated
178 Muddy Creek Church Rd.
Denver, PA 17517
1-800-952-4228
1-717-336-7528
<http://www.mgsincorporated.com>

If you believe that your vehicle has a defect which could cause a crash or could cause injury or death, you should immediately inform the National Highway Traffic Safety Administration (NHTSA) in addition to notifying MGS Inc.

If NHTSA receives similar complaints, it may open an investigation, and if it finds that a safety defect exists in a group of vehicles, it may order a recall and remedy campaign. However, NHTSA cannot become involved in individual problems between you, your dealer, or MGS Inc.

To Contact NHTSA, you may either call the Auto Safety Hotline toll free at 1-800-424-9393 or 1-202-366-0123 or write to:

NHTSA
U.S. Department of Transportation
400 7th Street SW, (NSA-11)
Washington, DC 20590

You can also obtain other information about the motor vehicle safety from the Hotline.

SECTION 2 : PREPARING TO TOW

2.1.1 Trailer Information

Your MGS trailer has an identification and information tag. The Trailer identification tag contains essential information for the safe use of your MGS trailer. The tag is generally located in the tongue area or front cross member of your trailer. If you can not locate your trailer identification tag, contact MGS.

Here is some important information included on the vehicle identification tag:

VIN: This is the Vehicle Identification Number.

GAWR: This is the maximum gross weight that each axle can support. It is the lowest of axle, wheel or tire rating.

GVWR: This is the maximum allowable gross weight of your trailer and its contents. The gross weight of your trailer includes the weight of the trailer and all of the items it is carrying, such as cargo, water, food and other supplies. GVWR is sometimes referred to as GTWR (gross trailer weight rating), or MGTW (maximum gross trailer weight). GVWR, GTWR and MGTW are all the same rating.

The sum total of the GAWR for all trailer axles may be greater or less than the GVWR. The total weight of the cargo and trailer must not exceed the GVWR.

EMPTY WEIGHT: The documents that accompany the trailer, such as the Manufacturer's Statement of Origin, are not a reliable source for "empty" or "net" weight information, because the shipping documents reflect average or standard weights and your trailer may be fitted with options. If you need to know the "empty" or "net" weight of your trailer, you must weigh it.

2.1.2 Trailer Braking System

Your MGS trailer may be equipped with a service brake system. It is important to identify the type of system employed on your trailer and understand its function.

Your MGS trailer will be equipped with one of the following types of service brake systems:

Electric Brakes

In an electric brake system, the trailer's service brakes are applied by employing electromagnets installed in each wheel. This system uses 12V power supplied by the tow vehicle. Your tow vehicle will need to be equipped with an electric brake controller to activate this system. If you want to learn more about electronic braking systems, please refer to your Dexter Axle manual included in your information packet

Hydraulic Surge Brakes

In a hydraulic surge brake system, the trailer's service brakes are applied by the inertial differential pressure developed between the tow vehicle and the trailer, during the braking process. This, in turn, creates a mechanical pressure which is applied to the push rod of the master cylinder in the hydraulic surge brake coupler which activates the service brakes. If you want to learn more about hydraulic surge braking systems, please refer to your specific hydraulic surge coupler manual included in your information packet



WARNING

If trailer and tow vehicle brakes do not work properly, death or serious injury can occur. Before every tow, road test the brakes in a safe area at no more than 30 m.p.h.



WARNING

Use of an underrated hitch or tow vehicle can result in loss of control leading to death or serious injury. Make certain your hitch and tow vehicle are rated for your trailer

SECTION 2 : PREPARING TO TOW

2.1.3 Tow Vehicle

If you are purchasing a new vehicle to tow your MGS trailer, consult the vehicle dealer for advice on how to equip the towing vehicle. The following information and equipment must be discussed with the vehicle dealer.

Overall Carrying and Towing Capacity of Vehicle

Vehicle manufacturers will provide you with the maximum capacities of their various models. No amount of reinforcement will give a 100 horsepower, 2500 pound truck the towing capacity that a 300 horsepower, 5000 pound truck has.

Electrical Connector

This component is used to connect the lighting and brake facilities on the trailer to the light and brake controls on the towing vehicle. See page 18 for some standard plug and wiring configurations.

Heavy Duty Cooling System

The engine on the tow vehicle is working harder when you are towing your trailer. Depending on the size of the trailer being towed, it may be necessary to have an engine oil cooler. Inadequate cooling may result in sudden engine failure. Check with the tow vehicle dealer.

Automatic Transmission Oil Cooler

A towing vehicle automatic transmission is handling more power when a trailer is being towed. Inadequate cooling will shorten transmission life, and may result in sudden transmission failure. Check with the tow vehicle dealer.

Fire Extinguisher

It is wise to carry a fire extinguisher in the tow vehicle.

Emergency Flares and Emergency Triangle Reflectors

It is prudent to carry these warning devices even if you are not towing a trailer. It is especially important to carry these when towing a trailer because the hazard flashers of your towing vehicle will not operate for as long a period of time when the battery is running the trailer lights in addition to the towing vehicle lights.

Suspension System

Sway bars, shock absorbers, heavy duty springs, heavy duty tires and other suspension components must be selected to accommodate the size and weight of the trailer that is going to be towed.

Brake Controller

This device is part of the tow vehicle and is necessary to operate the electric brakes on your trailer if so equipped. MGS provides electric or hydraulic surge brakes as standard equipment on trailers with a GVWR greater than 3,000 pounds.

The brake controller here is not the same as the safety breakaway brake controller that may be provided on the trailer.

Side View Mirrors

The size of the mirrors that are required depends on the size of the trailer that is being towed and your state law requirements. In addition, you must consider the fact that some states prohibit having extended mirrors on a towing vehicle, except while a trailer is actually being towed. In these cases, detachable extended mirrors are required. You must check with your dealer or the appropriate state agency for mirror requirements.

The following parts are involved in making a secure coupling between the trailer and the tow vehicle:

Coupler: A device that is on the tongue of the trailer, that makes the connection to the hitch on the tow vehicle.

Hitch: A device that is on the tow vehicle, to which the coupler of the trailer is attached.

The hitch also supports the weight of the trailer tongue.

Safety chains: To keep the trailer attached to the tow vehicle in case the coupler connection comes loose. In order to be effective, safety chains must be properly rigged to pull the trailer in case the coupler comes loose from the hitch. With proper rigging, it is possible to keep the tongue of the trailer from digging into the pavement, even if the coupler-to-hitch connection comes apart. See page 12 for proper rigging of safety chains.

Trailer lighting connector: A device that connects electrical power from the tow vehicle to the trailer, runs brakes and turns on brake lights, running lights, and turn signals as required.

Breakaway cable/chain: A device that actuates the emergency braking system on trailers equipped with service brake systems, (standard equipment on all MGS trailers with a GVWR greater than 3000 pounds) in case the coupler connection comes loose. In order to be effective, the breakaway cable/chain must be rigged to the tow vehicle with the amount of slack that will result in system actuation if the coupler connection comes loose.

Jack: A device on the trailer that is used to raise and lower the tongue (front) of the trailer. Sometimes called "landing gear."

SECTION 2 : PREPARING TO TOW

2.2 Coupling the trailer

A reliable coupling (or fastening) of the trailer to the tow vehicle is essential to safety. A loss of coupling may result in death or serious injury. Therefore, you must understand and follow all of the instructions for coupling.

Couplers

MGS produces trailers with a variety of coupler devices.

One of the sections on the following page will pertain to your trailer.

- Ball Hitch Coupler
- Lunette eye coupler

If the coupler on your MGS trailer does not resemble one of the couplers shown in the figures, consult the separate coupler instructions for proper operation. If you do not have separate coupler instructions, call MGS at 1-800-952-4228 for a free copy.

Your trailer may be supplied with one of the following couplers:

- A ball hitch coupler connects to a ball that is provided on or under the rear bumper of the tow vehicle. This system of coupling a trailer to a tow vehicle is sometimes referred to as “bumper pull.”
- A lunette eye connects to a pintle hook that is provided on the rear of the tow vehicle. This system of towing is sometimes referred to as a “pintle hitch.”

In both cases, your trailer may be equipped with a tongue jack to facilitate raising and lowering the coupler. The tongue jack is mounted to the A-frame (front, or tongue) part of the trailer. By rotating the jack handle clockwise, you will extend the jack and raise the tongue of the trailer.

TRAILER WITH BALL HITCH COUPLER

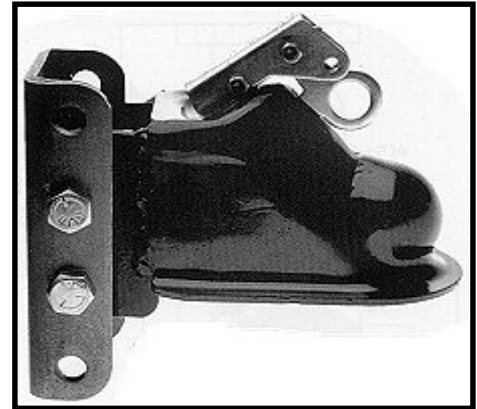

TWO BOLT ADJUSTABLE EYE W / CHANNEL



FOUR BOLT LUNETTE EYE



WARNING

An improperly coupled trailer can result in death or serious injury.

Do not move the trailer until:

- the coupler is secured and locked;
- the safety chains are secured to the tow vehicle
- the trailer jacks are fully retracted.

Do not tow the trailer on the road until:

- the trailer brakes are checked;
- the breakaway switch is connected to the tow vehicle; and
- the trailer lights are connected.

SECTION 2 : PREPARING TO TOW

MGS has selected a coupler with a rating that is equal to or greater than the GVW and tongue load of your trailer. It is your responsibility to provide a hitch and ball or pintle hook that match the size of the coupler, and that are adequately rated to pull the trailer. The tow vehicle, hitch and all components of the coupler must have a rated towing capacity equal to or greater than the trailer GVWR.

IT IS IMPERATIVE THAT THE HITCH BALL OR PINTLE HOOK BE OF THE SAME SIZE AND RATING AS THE COUPLER. If the hitch ball or pintle hook is not properly sized, is under rated, is loose or is worn, then the trailer can come loose from the tow vehicle, resulting in death or serious injury.

2.2.1 Before coupling the trailer to a tow vehicle with a ball hitch:

- Check the size and rating of hitch ball and verify that the coupler size and rating match the size and rating of the hitch ball. Hitch balls and couplers are marked with their size and rating.



WARNING

Coupler-to-hitch mismatch can result in uncoupling, leading to death or serious injury. Make sure the hitch and ball are rated for the trailer coupling. Make sure the hitch [ball size] matches the coupler.

- Check the condition of the hitch ball. Wipe the hitch ball clean and inspect it visually and by feel for flat spots, cracks and pits.



WARNING

A worn, cracked or corroded hitch ball can fail while towing, and may result in death or serious injury. Check the hitch ball for wear, corrosion and cracks before coupling the trailer. Replace worn, corroded or cracked hitch ball before coupling the trailer.

- Rock the ball to make sure it is tight to the hitch, and visually check that the hitch ball nut is solid against the lock washer and hitch frame.



WARNING

A loose hitch ball nut can result in uncoupling, leading to death or serious injury. Make sure the hitch ball nut is tight before coupling the trailer.

Prepare the coupler and hitch:

- Lubricate the hitch ball and the inside of the coupler with a thin layer of automotive bearing grease.
- Release the coupler locking mechanism. In the released position, the coupler is able to drop fully onto the hitch ball.

Couple the trailer to the tow vehicle:

- Using the trailer jack, lower the trailer and cause the coupler to fully engage the hitch ball. If the coupler does not line up with the hitch ball, adjust the position of the tow vehicle.
- Engage the coupler locking mechanism. In the engaged position, the locking mechanism holds the coupler securely to the hitch ball.
- Make sure that the coupler is all the way on the hitch ball and the locking mechanism is engaged. A properly engaged locking mechanism will permit the coupler to raise the rear of the tow vehicle. Using the trailer jack, test to see that you can raise the rear of the tow vehicle by 1 inch.

NOTICE

The tongue jack can be damaged by overloading. Do not use the tongue jack to raise the tow vehicle more than 3 inches.

If the coupler cannot be secured to the hitch ball, do not tow the trailer. Call MGS or your service center for assistance.

- Lower the trailer so that its full tongue weight is held by the hitch, and continue retracting the jack to its fully retracted position.

SECTION 2 : PREPARING TO TOW

2.2.2 Before coupling the trailer to the tow vehicle with pintle hitch:

- Check the size and rating of the pintle hook and verify that the size and the rating match the size and rating of the lunette eye. Pintle hooks and lunette eyes are marked with their rating



WARNING

Coupler-to-hitch mismatch can result in uncoupling, leading to death or serious injury.

Make sure the pintle hook and lunette eye are rated for the trailer coupling.

Always check for wear or binding before coupling.

- Check the condition of the pintle hook. Wipe the pintle hook clean and inspect it visually and by feel for flat spots, cracks and pits.



WARNING

A worn or cracked lunette eye or pintle hook can fail while towing, and may result in death or serious injury.

Check the lunette eye and pintle hook for wear, corrosion and cracks before coupling the trailer.

Replace worn, corroded or cracked components before coupling the trailer.

- Check the condition of the lunette eye. Wipe the inside and outside of the lunette eye clean. Inspect the lunette eye visually for cracks and deformations; and feel the surface of the coupler for worn spots and pits.
- Make sure the lunette eye is tight to the tongue of the trailer, that is, that all coupler fasteners are visibly solid against the trailer frame.
- Raise the bottom surface of the coupler to be above the top of the pintle hook. Use the jack if one is provided, or use appropriate blocking to support the trailer tongue if no jack is provided.
- Release the coupler locking mechanism. Pintle eye couplers have a locking mechanism that closes the hook and locks it with an outside handle. In the released position, the lunette eye is able to drop fully onto the pintle hook. Release the lock by removing the spring pin and

pulling the handle lever up and toward you to the rear stop on the casting. The handle can be held in the released position by installing the spring pin back into the locking hole. You can now swing the top of the hook “up.”

Couple the trailer to the tow vehicle:

- Using the trailer jack, lower the trailer and cause the lunette eye to fully engage the pintle hitch. If the lunette eye does not line up with the pintle hitch, adjust the position of the tow vehicle.
- Engage the coupler locking mechanism. In the engaged position, the locking mechanism closes the pintle hitch so that the lunette eye is trapped.



WARNING

The lunette eye must be free to move within the pintle hook on both axis without binding.

Be sure to check that there is no binding and that the eye is free to swing on the horizontal and vertical axis'

- Make sure that the lunette eye is trapped by the pintle hook and the locking mechanism is engaged. A properly engaged locking mechanism will permit the coupler to raise the rear of the tow vehicle. Using the trailer jack, test to see that you can raise the rear of the tow vehicle by 1 inch.

NOTICE

The tongue jack can be damaged by overloading. Do not use the tongue jack to raise the tow vehicle more than 3 inches.

SECTION 2 : PREPARING TO TOW

If the coupler cannot be secured to the hitch ball, do not tow the trailer. Call MGS or your service center for assistance.

- Lower the trailer so that its full tongue weight is held by the hitch, and continue retracting the jack to its fully retracted position.

Rig the safety chains:

- Visually inspect the safety chains and hooks for wear or damage. Replace worn or damaged safety chains and hooks before towing.
- Rig the safety chains so that they:
 - are securely fastened to the hitch or tow vehicle frame. Do not attach to ball mount.
 - cross underneath the coupler, to permit turning; and
 - have minimum slack, so if the trailer uncouples, the safety chains can hold the tongue up above the road.



! WARNING

Incorrect rigging of the safety chain can result in loss of control of the trailer and tow vehicle, leading to death or serious injury, if the trailer uncouples from the tow vehicle.

Fasten to frame of tow vehicle, not to hitch or ball.

Cross underneath hitch and coupler with minimum slack to permit turning and to hold tongue up, if the trailer comes loose.

Attach and test the breakaway brake system:

When in working order and properly connected, the breakaway brake system will apply the service brakes on your trailer in the event that the coupler or hitch fails. The tow vehicle will still be attached to the trailer by the safety chains, and having the brakes applied at the trailer's axles promotes a controlled stopping of the trailer/tow vehicle combination.

2.2.3 Breakaway system - Electric

An electric breakaway brake system includes a battery, a switch that includes a pull pin, and a breakaway brake controller. In addition to reading and following the instructions here, read and follow the instructions that have been prepared by the breakaway brake controller manufacturer. If you do not have these instructions, call MGS Inc. at 1-800-952-4228 for a free copy. The breakaway brake system may be equipped with a charging facility that can draw power from the tow vehicle. If the electrical system on your tow vehicle does not provide power to the breakaway brake battery, it will be necessary for you to periodically charge the battery to keep the breakaway brake system in working order.



- Visually inspect the breakaway brake system for broken parts.
- Check the breakaway cable for wear/corrosion.
- Connect the pull pin cable to the tow vehicle so that the pull pin will be pulled out before all of the slack in the safety chains is taken up.
- Do not connect the pull pin cable to a safety chain or to the hitch ball or hitch ball assembly. This would keep the safety breakaway brake system from operating when it is needed.

! WARNING

An ineffective breakaway brake system can result in a runaway trailer, if the coupler or ball hitch fails, leading to death or serious injury.

• Test the function of the breakaway brake system before towing the trailer. Do not tow the trailer if the breakaway brake system is not working; have it serviced or repaired.

• Connect the breakaway cable to the tow vehicle -

- NOT to the safety chain; and**
- NOT to the hitch, ball or support**

SECTION 2 : PREPARING TO TOW

Testing your electric breakaway system:

- Unplug the electrical connection from the tow vehicle.



WARNING

Failure to unplug the trailer to tow vehicle electrical connection while breakaway system is energized could cause an electrical overload resulting in fire and serious injury.

- Remove the pull pin from the switch and test tow the trailer, at less than 5 m.p.h. You should feel the trailer resisting being towed, but the wheels will not necessarily be locked.
- Promptly replace the pull pin. The breakaway brake system battery discharges rapidly when the pull pin is removed.

Towing the trailer with the breakaway brake system activated causes brake overheating and can result in permanent brake failure.



WARNING

Failure to replace the pull pin can result in ineffective brakes, leading to loss of control, serious injury or death.

- **Reconnect the trailer to tow vehicle electrical connection.**

If you store your trailer for three months, or during winter months:

- Store the battery indoors; and
- Charge the battery every three months.

The breakaway brake battery must be replaced according to the battery manufacturer's instructions, typically every two years.

2.2.4 Breakaway system - Hydraulic

The hydraulic breakaway brake system includes a coupler-mounted actuator arm and an actuator chain or cable. In addition to reading and following the instructions here, read and follow the instructions that have been prepared by the actuator manufacturer. If you do not have these instructions, call MGS Inc. at 1-800-952-4228 for a free copy.

The hydraulic breakaway system is an integral part of the service brake system and relies on proper maintenance of the service brake system in order to function in the event the trailer becomes unhooked from the tow vehicle.

- Visually inspect the breakaway brake system for broken parts.
- Check the breakaway cable/chain for wear and corrosion.
- Connect the cable/chain to the tow vehicle so that the actuator lever will be pulled into the operating position before all of the slack in the safety chains is taken up.
- Do not connect the pull pin cable to a safety chain or to the hitch ball or hitch ball assembly. This would keep the safety breakaway brake system from operating when it is needed.



WARNING

An ineffective breakaway brake system can result in a runaway trailer, if the coupler or ball hitch fails, leading to death or serious injury.

- **Test the function of the breakaway brake system before towing the trailer. Do not tow the trailer if the breakaway brake system is not working; have it serviced or repaired.**
- **Connect the breakaway cable to the tow vehicle -**
 - **NOT to the safety chain; and**
 - **NOT to the hitch, ball or support**

You will need to refer to the actuator manual to properly release the actuator lever.

- To test: pull the actuator arm forward. It will lock in the applied position.
- Test tow the trailer, at less than 5 m.p.h. You should feel the trailer resisting being towed, but the wheels will not necessarily be locked.
- Return the actuator lever to the released position.



WARNING

Failure to return the actuator lever to the released position can result in ineffective brakes, leading to loss of control, serious injury or death.

SECTION 2 : PREPARING TO TOW

2.3 Loading the Trailer

An improperly loaded trailer is dangerous on the road. Many accidents and deaths are caused by improper trailer loading. Safely loading a trailer is an activity that requires attention to many factors:

- Overall load weight;
- Load weight distribution; and
- Securing the load properly.

To determine that you have loaded the trailer within its rating, you must consider the distribution of weight, as well as the total weight of the trailer and its contents.

The total weight of the trailer and its contents must never exceed the GVWR.

The weight exerted on the axles must never exceed the sum total of the GAWR's as stated on the VIN tag. In order to determine the axle weight, the trailer must be weighed in the following manner: Trailer is weighed while attached to tow vehicle with no part of the tow vehicle on the scale. This will provide a good indication of the amount of axle weight. Usually, the wheel, tire and axle ratings determine the "GAWR," and the GVWR determines the maximum weight of the trailer and its contents.

WARNING

An overloaded trailer can result in failure or in loss of control of the trailer, leading to death or serious injury. Never load a trailer so that the weight on any tire exceeds its rating. Never exceed the trailer Gross Vehicle Weight Rating (GVWR). Never exceed an axle Gross Axle Weight Rating (GAWR).

It is also essential to distribute the load so that the tongue has enough weight to provide predictable handling, and so that no single tire is overloaded. Rules of thumb for proper tongue weight are:

10 - 15% of GVW

"GVW" is the total weight of the trailer and all cargo. The cargo should also be distributed so that the trailer center of gravity is as low as possible.

- Load heavy items on the floor and over the axles.
- Load additional items evenly, right to left, to achieve uniform tire loading.
- Distribute the load front-to-rear to obtain proper tongue weight.



WARNING

An overloaded trailer can result in failure or in loss of control of the trailer, leading to death or serious injury. Never load a trailer so that the weight on any tire exceeds its rating. Never exceed the trailer Gross Vehicle Weight Rating (GVWR). Never exceed an axle Gross Axle Weight Rating (GAWR).

2.3.1 Checking Tongue Weight

Tongue weight can be measured on a fully loaded trailer by several methods. In each method, the trailer must be level, as it will be when being towed. The recommended method of checking tongue weight is to use an accessory called a "tongue weight scale."



WARNING

An unrestrained trailer can fall off its support, resulting in serious injury or death. Block trailer wheels, front and rear, before checking tongue weight.

The tongue weight can also be checked at an axle weighing scale.



WARNING

An improperly distributed load can result in loss of control of the trailer, and can lead to death or serious injury.

- Proper tongue weight is essential for stable trailer handling.
- Distribute the load front to rear to provide proper tongue weight.
- Distribute the load evenly, right and left, to avoid tire overload.
- Keeping the center of gravity low and centered is essential to minimize the risk of tip-over.

2.3.2 Loading Cargo

You are responsible to secure your cargo in such a way that it does not shift on the trailer, while the trailer is being towed.



WARNING

A shifting load can result in failure, or to loss of control of the trailer, and can lead to death or serious injury. You must tie down all loads with proper sized fasteners, ropes, straps, etc. to prevent the load from shifting while trailering.

SECTION 2 : PREPARING TO TOW

2.4 Checking the Trailer Before and During Each Tow

PRE-TOW - Before you begin your towing, double-check all of these items:

- Coupler secured and locked, [section 2.2](#)
- Safety chains properly rigged to tow vehicle, not to hitch or ball, [section 2.2](#)
- Safety breakaway switch cable fastened to tow vehicle, not to safety chain, [section 2.2](#)
- Tires, [section 1.2](#)
 - Pressure - check “cold”
 - Tread and wear patterns
 - Cuts, bulges, cracks and visible cords
- Wheels - cracks, dents and bends, [section 1.2](#)
- Lug nuts tight, [section 1.2](#)
- Test of lights: Tail, Stop and Turn
- Cargo appropriately restrained, [section 2.3](#)
- Fire extinguisher
- Flares and reflectors

REGULAR STOPS

After each 50 miles, or one hour of towing, stop and check the following items:

- Coupler is secure
- Safety chains are fastened and have not been dragging
- Tires not visibly low on pressure
- Cargo secure

SECTION 2 : PREPARING TO TOW

2.5 Breaking in a New Trailer

The wheel and brake systems on your trailer require special attention early in their lives.

Wheel lugs can shift and settle quickly after being first assembled, and must be checked after the first 10, 25 and 50 miles of driving. Failure to perform this check may result in a wheel parting from the trailer, and a crash leading to death or serious injury.



WARNING

Lug nuts are prone to loosen after being first assembled. Death or serious injury can result. Check lug nuts for tightness on a new trailer, and after remounting a wheel at 10, 25 and 50 miles.

Brake shoes and drums experience a rapid initial wear. The brakes must be adjusted after the first 200 miles of use, and each 3,000 miles thereafter. Some axles are equipped with a mechanism that will automatically adjust the brake shoes when the trailer is “hard braked” from a forward direction. A hard stop is used to:

1. Confirm that the brakes work;
2. Check that the trailer brakes are properly synchronized with the tow vehicle brakes; and
3. For many braking systems, a hard stop will automatically adjust the brake shoes.

If your trailer is not equipped with automatically adjusting brakes, the brakes will need to be manually adjusted.

2.6 Synchronizing the Brakes (Electric Brakes Only)

Trailer brakes are designed to work in synchronization with the brakes on the tow vehicle. Never use either brake system alone to stop the combined tow vehicle and trailer.

When the tow vehicle and trailer braking systems are synchronized, both braking systems contribute to slowing, and the tongue of the trailer will neither dive nor rise sharply.

To insure safe brake performance and synchronization, read and follow the axle/brake and the brake controller manufacturers’ instructions. If you do not have these instructions, call MGS at 1-800-952-4228 for a free copy.



WARNING

If trailer and tow vehicle brakes do not work properly, death or serious injury can occur. Before every tow, road test the brakes in a safe area at no more than 30 m.p.h.

2.7 Uncoupling the Trailer

BALL HITCH/TONGUE JACK UNCOUPLING

Follow these steps to uncouple your trailer from the tow vehicle:

- Block trailer tires to prevent the trailer from rolling, before jacking the trailer up.
- Disconnect the electrical connector.
- Disconnect the breakaway brake switch cable. Do not pull the pin out of the switch.
- Disconnect the safety chains from the tow vehicle.
- Unlock the coupler.
- Rotate the jack handle (or crank) clockwise. This will slowly extend the jack and transfer the weight of the trailer tongue to the jack.
- Continue to extend the jack(s), making sure that the ground is providing stable and level support for the trailer.

SECTION 3 : TRAILER TOWING GUIDE

As with driving a car, driving with a trailer in tow is a learning experience. And, the hazards are greater than when driving a vehicle without a trailer. You are responsible for keeping your vehicle and trailer in control, and for all the damage that is caused if you lose control of your vehicle and trailer.

Driving a vehicle with a trailer in tow is vastly different from driving the same vehicle without a trailer in tow. Acceleration, maneuverability and braking are all diminished with a trailer in tow. It takes longer to get up to speed, you need more room to turn and pass, and more distance to stop when towing a trailer.

As you did when learning to drive an automobile, find an open area with little or no traffic for your first practice trailering. Of course, before you start towing the trailer, you must follow all of the instructions for inspection, testing, loading and coupling. Also, before you start towing, adjust the mirrors so you can see the trailer as well as the area to the rear of it.

Drive slowly at first, 5 m.p.h. or so, and turn the wheel to get the feel of how the tow vehicle and trailer combination responds. Next, make some right and left hand turns. Watch in your rearview mirror to see how the trailer follows the tow vehicle.

Turning with a trailer attached requires more room.

Stop the rig a few times from speeds no greater than 10 m.p.h. If your trailer is equipped with brakes, try using different combinations of trailer/electric brake, and tow vehicle brake. Note the effect that the trailer brakes have when they are the only brakes used. When properly adjusted, the trailer brakes will come on just before the tow vehicle brakes.

It will take practice to learn how to back up a tow vehicle with a trailer attached. Take it slow. Before backing up, get out of the tow vehicle and look behind the trailer to make sure that there are no obstacles. Some drivers place their hands at the bottom of the steering wheel, and while the tow vehicle is in reverse, “think” of the hands as being on the top of the wheel. When the hands move to the right (counterclockwise, as you would do to turn the tow vehicle to the left when moving forward), the rear of the trailer moves to the right. Conversely, rotating the steering wheel clockwise with your hands at the bottom of the wheel will move the rear of the trailer to the left, while backing up. If you are towing a bumper hitch rig, be careful not to allow the trailer to turn too much, because it will hit the rear of the tow vehicle. To straighten the rig, either pull forward, or turn the steering wheel in the opposite direction.

Safe Trailer Towing Guidelines

- Before towing, check coupling, safety chain, safety brake, tires and lights.
- Check the lug bolts for tightness.
- Check coupler tightness after towing 50 miles.
- Adjust the brake controller to engage the trailer brakes before the tow vehicle brakes. (Your MGS dealer can assist you by making this adjustment.)
- Use your mirrors to verify that you have room to change lanes or pull into traffic.
- Use your turn signals well in advance.
- Allow plenty of stopping space for your trailer and tow vehicle.
- Do not drive so fast that the trailer begins to sway due to speed. Never drive faster than 60 m.p.h.
- Allow plenty of room for passing, a rule of thumb is that the passing distance with a trailer is 4 times the passing distance without a trailer.
- Shift your automatic transmission into a lower gear for city driving.
- Use lower gears for climbing and descending grades.
- Do not ride the brakes while descending grades, they may get so hot that they stop working and then you will have a potential runaway tow vehicle and trailer.
- To conserve fuel, don’t use full throttle to climb a hill. Instead, build speed on the approach.
- Slow down for bumps in the road. Be off the brake when crossing the bump.
- Do not brake while in a curve unless absolutely necessary. Instead, slow down before you enter the curve and power through the curve. This way, the towing vehicle remains “in charge.”
- Do not apply the brakes to correct extreme trailer swaying. Continued pulling of the trailer, and even slight acceleration, will provide a stabilizing force.
- Make regular stops, about once each hour. Confirm that the coupling is in order (locked, electrical connectors made, and breakaway switch pull pin cable has an appropriate amount of slack), that the tires are not visibly low on pressure, and that your cargo is secure and in good condition.

SECTION 4 : TECHNICAL REFERENCE

4.1 Trailer Lighting Electrical Connection

The electrical wiring on your MGS trailer has been designed and built in accordance with all the Federal Motor Vehicle Safety Standards that were in effect when the trailer was produced.

The figure below illustrates the wiring code specified by your fleet representatives

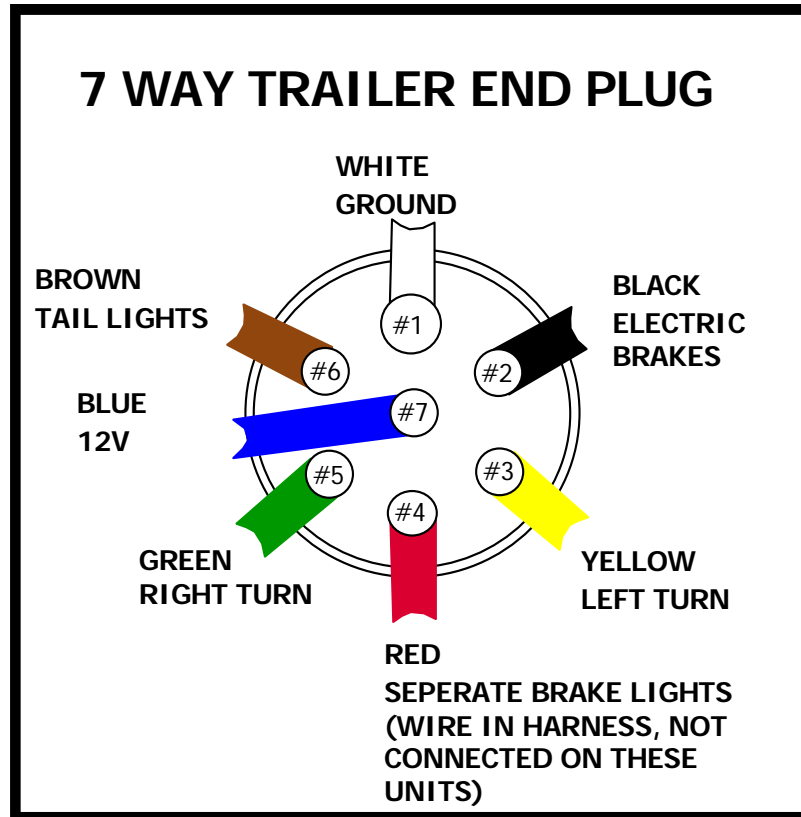

Pin #1 – White	Ground
Pin #2 – Black	Electric Brake Controller (If applicable)
Pin #3 – Yellow	Left Turn
Pin #4 – Red	Stop Lights
Pin #5 – Green	Right Turn
Pin #6 – Brown	Tail,Clearance,Markers & License Plate Light
Pin #7 – Blue	Trailer ABS–Constant Power w/Ignition on (If applicable)

SECTION 4 : TECHNICAL REFERENCE

Your trailer is equipped with two wheel chock holders that will be equipped with wheel chocks by your fleet division. MGS recommends chocking the trailer before uncoupling, loading, unloading or storing the unit. Wheel chock holders are located on the front of each fender as shown in [figure 1](#)



FIGURE 1

Prior to uncoupling the trailer, lower the rear stabilizer jacks at the rear of the trailer so that they are as close to the ground as possible. You can use either upper or lower hole in the socket to secure the jack. [figure 2](#)



FIGURE 2

Pull pin and rotate tongue jack into position. Replace pin as shown in [figure 3](#). Release coupler and raise front of trailer until rear stabilizers come firmly into contact with the ground. Completely unhook trailer from tow vehicle and level.



FIGURE 3

SECTION 4 : TECHNICAL REFERENCE



Remove the engine tarp and the reel tarp. Tarps are secured with bungee straps or adjustable clips shown in [figure 4](#). To release the clips, squeeze both locking tabs.

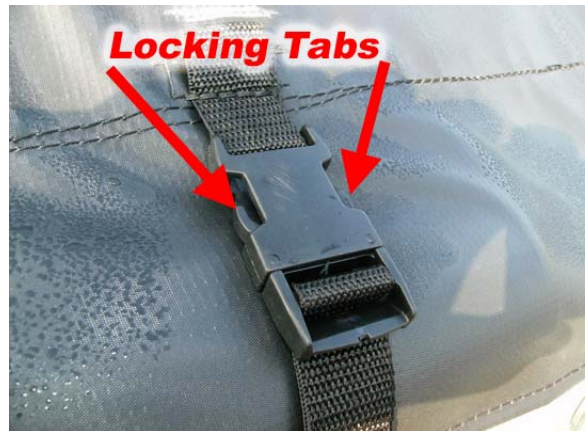
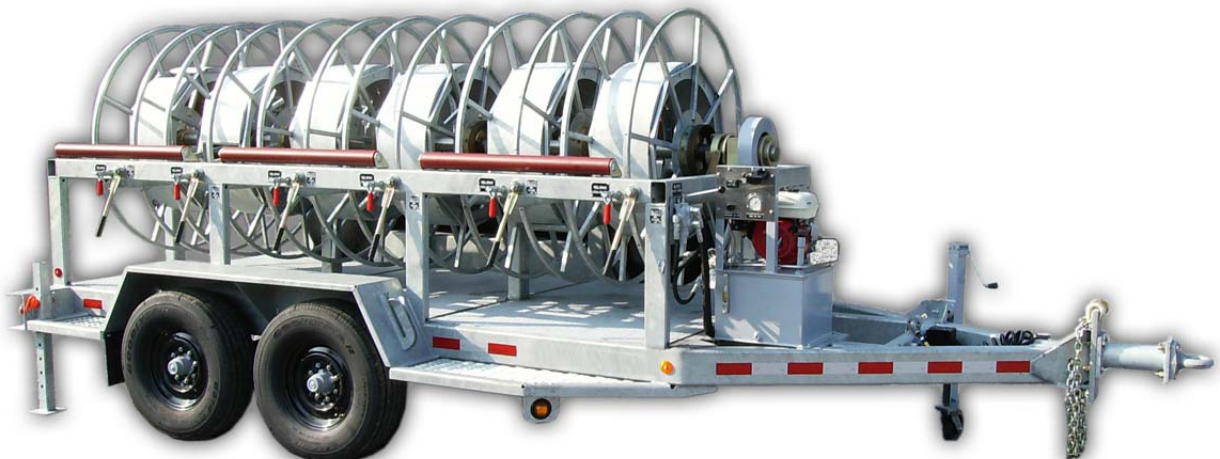

FIGURE 4



COMPONENTS OF THE REEL DRIVE AND STORAGE MECHANISM

Each reel is controlled by its own individual brake and clutch shown in [figure 5](#).



FIGURE 5

A single Stainless steel drive shaft powers all six reels [figure 6](#).



FIGURE 6

Each reel has its own set of brake and clutch controls mounted outside the reel frame. [figure 7](#).



FIGURE 7

SECTION 4 : TECHNICAL REFERENCE

OPERATING THE REEL DRIVE MECHANISM

Begin by uncovering the power unit. [figure 8](#).



WARNING

Hot Engine - do not touch!
Engine can cause serious burns
after a very short run tim
serious burns can
occur upon touching



WARNING

Moving Parts - Keep hands and body outside
of Trailer unless
ENGINE IS OFF!
REEL BRAKES ARE LOCKED!
CLUTCH IS DISENGAGED!
serious injury can occur if any part(s) of
body come in contact with Moving Parts



FIGURE 8

CONTROL PANEL DIAGRAM



FIGURE 9

SECTION 4 : TECHNICAL REFERENCE

The oil temp/level sight gauge is located on the hydraulic tank. [figure 10](#). This tank shows the hydraulic fluid level and incorporates a small thermostat to indicate hydraulic fluid temperature. Do not operate if fluid level is below 1/2, temperature is over 120 degrees F or if fluid appears milky



FIGURE 10

The filter condition gauge is located above the oil reservoir near the oil filter. [figure 11](#). This gauge measures the resistance pressure through the filter to indicate when it is becoming full of debris. The gauge only operates when the motor is running and hydraulic power is being used. Change the filter if the needle enters the yellow zone. Never attempt to operate the unit with the needle in the red zone

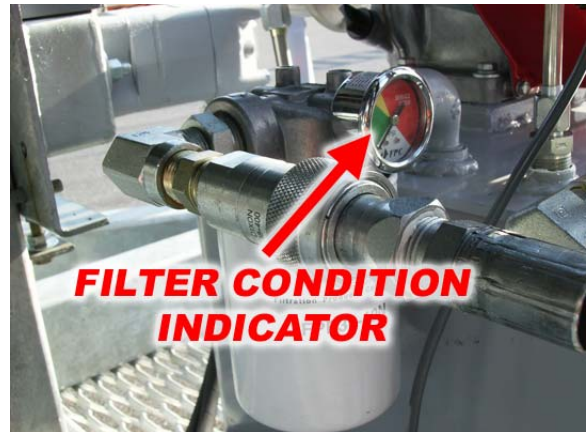

FIGURE 11

Hydraulic oil fill is located on top of the tank as shown in [figure 12](#). Always make sure the cap is tight and never add oil except for the brand and type recommended in the service manual.

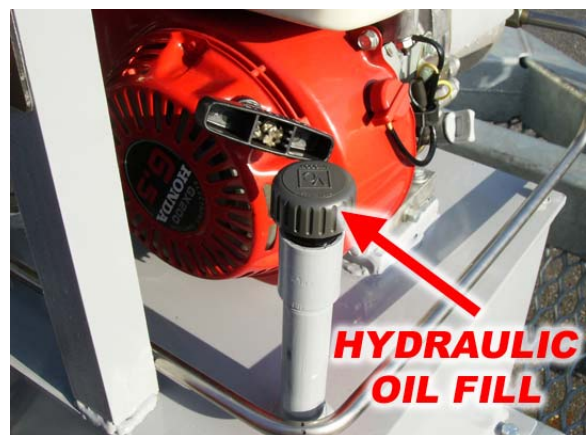

FIGURE 12

SECTION 4 : TECHNICAL REFERENCE

STARTING THE HPU

Please refer to maintenance manual if engine does not start with the following procedure
Turn on / off switch to on position [figure 13](#). This switch is also used to turn the motor off

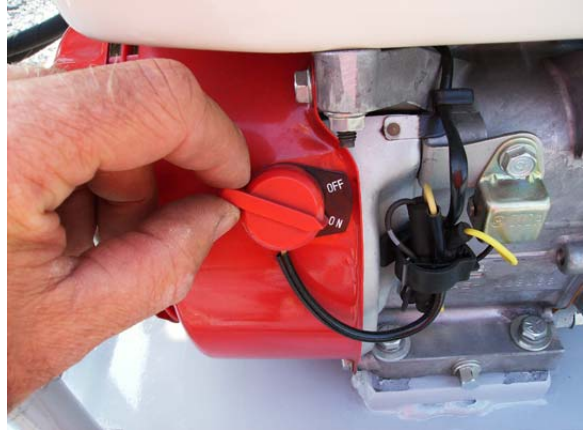

FIGURE 13

After checking the fuel tank, open the fuel shutoff switch. [figure 14](#). The fuel shutoff should always be in the closed position while the engine is not running.

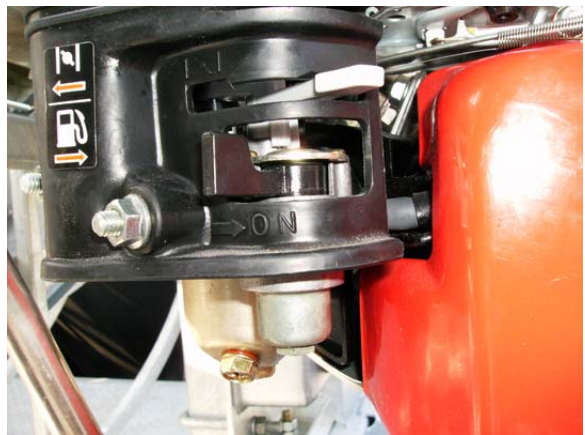

FIGURE 14

Set the choke if the engine is cold [figure 15](#)
After the engine is warmed up, the choke should be turned off

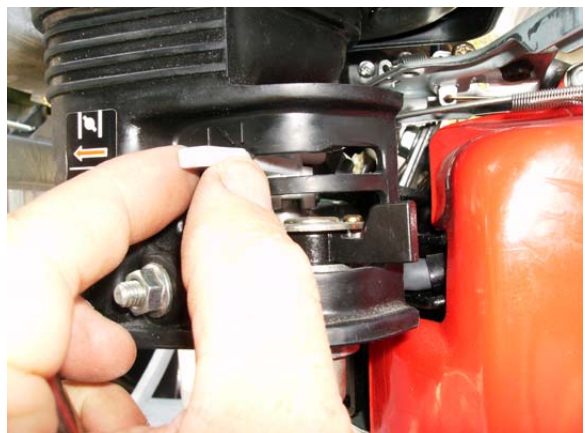

FIGURE 15

SECTION 4 : TECHNICAL REFERENCE

STARTING THE HPU

Grasp the pull rope and pull sharply to start the engine. [figure 16](#). In cold weather, it may take several pulls to start the motor

 WARNING
Moving Parts - Keep hands and body outside of Trailer unless ENGINE IS OFF!
REEL BRAKES ARE LOCKED!
CLUTCH IS DISENGAGED!
serious injury can occur if any part(s) of body come in contact with Moving Parts



FIGURE 16

Once engine reaches operating temperature, adjust idle speed as desired. [figure 17](#).



FIGURE 17

SECTION 4 : TECHNICAL REFERENCE

OPERATION

Each reel has an identical set of controls as indicated in [figure 16](#). Before starting engine, make sure that all clutches are disengaged and all reel brakes are engaged as shown in [figure 17](#).

<p>! WARNING</p> <p>Moving Parts - Keep hands and body outside of Trailer unless ENGINE IS OFF! REEL BRAKES ARE LOCKED! CLUTCH IS DISENGAGED! serious injury can occur if any part(s) of body come in contact with Moving Parts</p>
--

For Payout operations, the hydraulic system need not be used. Simply disengage the brake and be sure to disengage the clutch. Feed wire manually over the polyurethane rollers and off the trailer. All six reels can be payed out simultaneously if done manually

If hydraulic system is utilized, unit is designed for single reel at a time payout or retrieval.

Use the following procedure:

1. Ensure that all clutches are disengaged and reel brakes are engaged
2. On reel to be used, disengage reel brake and engage clutch (Note: It may be necessary to position reel manually in order to engage clutch.) **Never engage clutch while drive shaft is in motion.**
3. Follow engine starting procedure if engine is not started.
4. Move Rotation lever ([FIGURE 18](#)) upward to payout or downward to retrieve.

If reel does not spin, Increase hydraulic pressure and/ or increase engine speed (refer to [FIGURES 9 AND 17](#)). Note pressure gauge reading for future reference. Reel speed and torque can be modified by adjusting these controls.

NEVER USE A VEHICLE OR EQUIPMENT TO PULL AGAINST THE DRIVE MECHANISM WHEN PAYING OUT CABLE.

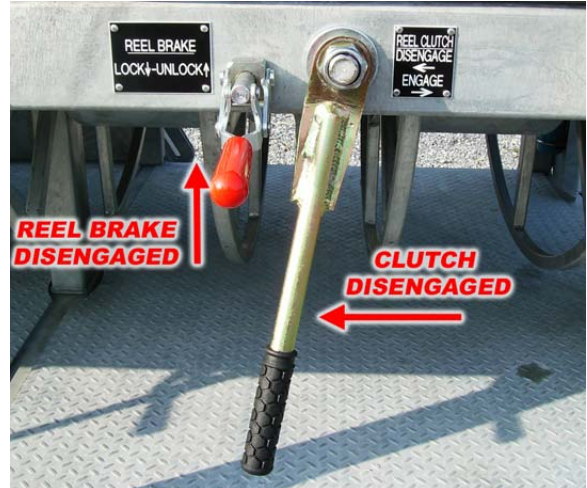

FIGURE 16



FIGURE 17



FIGURE 18

SECTION 4 : TECHNICAL REFERENCE

OPERATION



WARNING

Engine must be OFF and Clutch Disengaged before loading Cable unto Reel
Serious injury can occur to hands and body if reels are in Motion

In all cases, cable is to be routed as shown in [figure 19](#).

Use the slot shown in [figure 20](#) to anchor the cable end.

In the event of hydraulic failure, the trailer is capable of manual retrieve operations. To manually retrieve:

1. Locate main drive hub located in the center of the *front* of the trailer. [figure 21](#)
2. Disengage main drive by pulling out on the outer engagement ring. This will disengage the drive sprocket/hydraulic motor. [figure 22](#)
3. Locate manual drive lug at *rear* of trailer (in same location as main drive hub) [figure 23](#)
4. Locate breaker bar (stored in frame near manual drive lug). [figure 24](#)
5. Use breaker bar to rewind reel manually [figure 25](#)

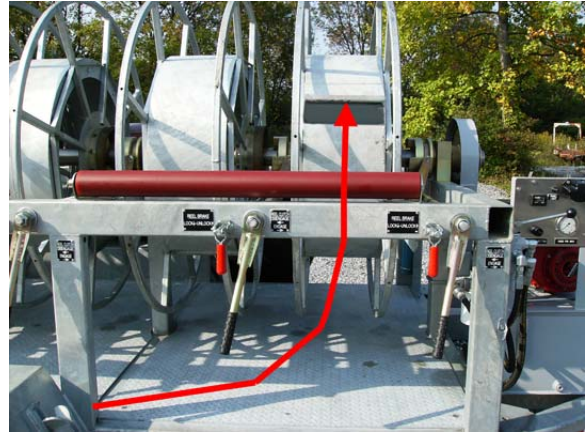

FIGURE 19



FIGURE 20



FIGURE 21



FIGURE 22

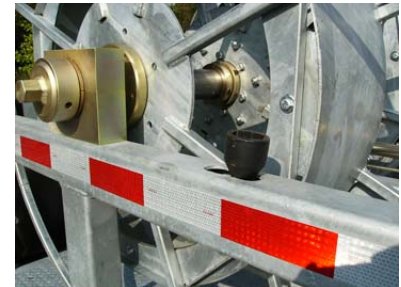

FIGURE 23



FIGURE 24

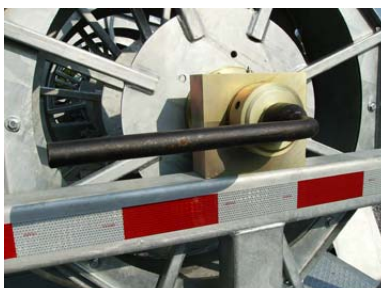

FIGURE 25

SECTION 4 : TECHNICAL REFERENCE

OPERATION

When operation is complete, wait until engine is cool before replacing tarp.
In preparation for towing or storage, Lock all reel brakes. Re-tarp trailer and power unit.
Always keep power unit covered when trailer is not in use.

**Be sure to have all operators view the training video after familiarizing themselves with this manual.
If you have any questions regarding the operation of this trailer, contact:**

**MGS Incorporated
178 muddy Creek Church Road
Denver, PA 17517**

1-800-952-4228

SECTION 4.3 TECHNICAL REFERENCE - DIMENSIONS

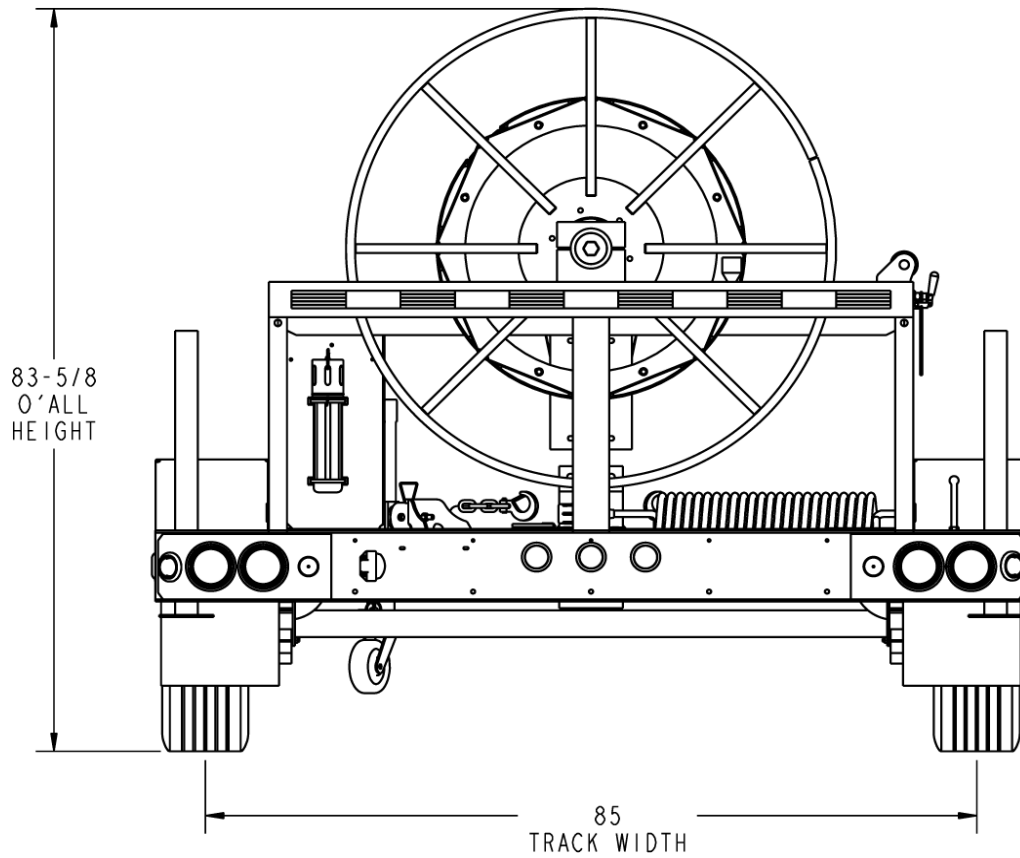
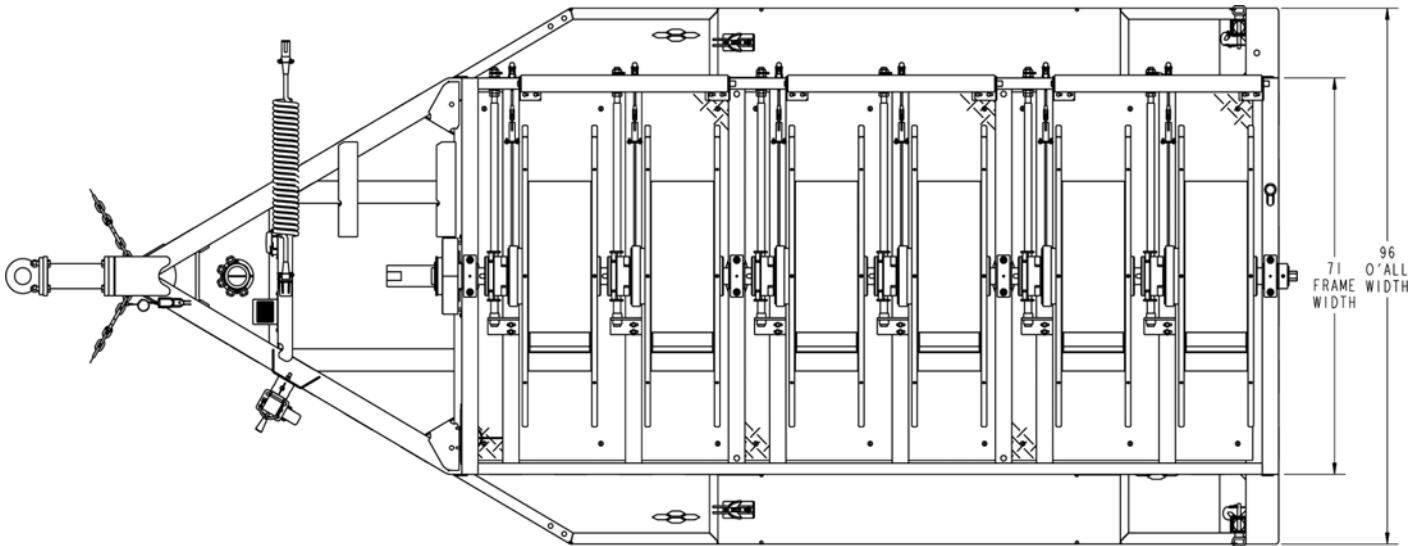



MARTIN LIMESTONE, INC.

SUBSIDIARY OF NEW ENTERPRISE STONE & LIME CO., INC.

BLUE BALL, PA. 17506

PLANT NAME DENVER
 & NUMBER PLANT NUMBER 08 PHONE (717) 354-1370

ORDER NO	TICKET NUMBER	DATE	TIME
	M SCALE 2 0849221	09/08/2008	11:37 AM
CUSTOMER ID	S O L D M G S INC 178 MUDDY CREEK CHURCH RD DENVER, PA 17517		
9625752			
22 99			
JOB SITE ID	S H I P M U L T I - R E E L T R A I L E R	STATE PA	CITY ZONE
PRODUCT I.D.	PRODUCT DESCRIPTION		
98125	WEIGHING		
QUOTATION NO./CUSTOMER P.O.	EXTRA CHARGE, PLOWED/NOT WORKED	CUSTOMER PHONE NO.	
	EXTRA CHARGE, LESS THAN 1 TON/ACRE		
TAG NO.	NO. AXLES	TRUCK NO.	CARRIER NAME
	0	08	
			CARRIER CODE

Pick-up	Freight PPD	Freight Collect	ACCUMULATIVE QUANTITIES	CHARGE	C.O.D.
XX				XX	
US Weight	METRIC Weight	Gross	Ordered	MATERIAL	UNIT PRICE
6,580			Today	HAUL	TOTAL
		Tare	Loads		
6,580			To Date	ADD'L CHARGES	
		Net	Loads		
			Accumulated Cash Sale	TAX	

WEIGHED BY	020898	TOTAL THIS LOAD
BRENDA J. TUCKER		

INSPECTORS SIGNATURE	JOB ARRIVAL TIME	JOB DEP'T TIME

RECEIVED ABOVE MATERIAL IN GOOD CONDITION	A SERVICE CHARGE, NOT TO EXCEED THE MAXIMUM ALLOWABLE BY LAW, WILL BE APPLIED TO ALL AMOUNTS OVER 30 DAYS PAST DUE.
X <i>[Signature]</i>	

DELIVERY INFORMATION

6580= TOTAL WEIGHT

YOUR BUSINESS IS GREATLY APPRECIATED.

PLANT DIRECTORY					
01 WEAVERLAND PLANT (717) 354-1370	03 VIOLA WAREHOUSE (302) 284-9151	06 BURKHOLDER PLANT (717) 354-1370	11 HONEY BROOK (610) 273-2921	13 SCHOENECK PLANT (717) 354-1370	
02 LIMEVILLE PLANT (717) 354-1370	04 DELMAR WAREHOUSE (302) 284-9151	08 DENVER PLANT (717) 354-1370	12 NARVON PLANT (717) 354-4941		



INNOVATORS AND MANUFACTURERS OF TRANSPORTATION EQUIPMENT

The information contained in this manual was current at time of publication. This manual is updated regularly. Information supplied is subject to change. Please contact MGS with any questions that you may have regarding the safe operation of your trailer. If you need copies of any of the documents mentioned in this manual, contact us

for a free copy:

MGS Inc.

178 Muddy Creek Church Rd.

Denver, PA 17517

1-800-952-4228